

1 TÉRREO
1 : 200

UNIVERSIDADE FEDERAL DO AMAZONAS			
CURSO	ARQUITETURA E URBANISMO	ALUNA	GIOVANNA PERIN MELO
DISCIPLINA	TFG II	TURNO	VESPERTINO
ORIENTADORA	TAIS FURTADO PONTES	DATA	05/06/2023
TÍTULO	PLANTA BAIXA TERREO	ESCALA	INDICADA

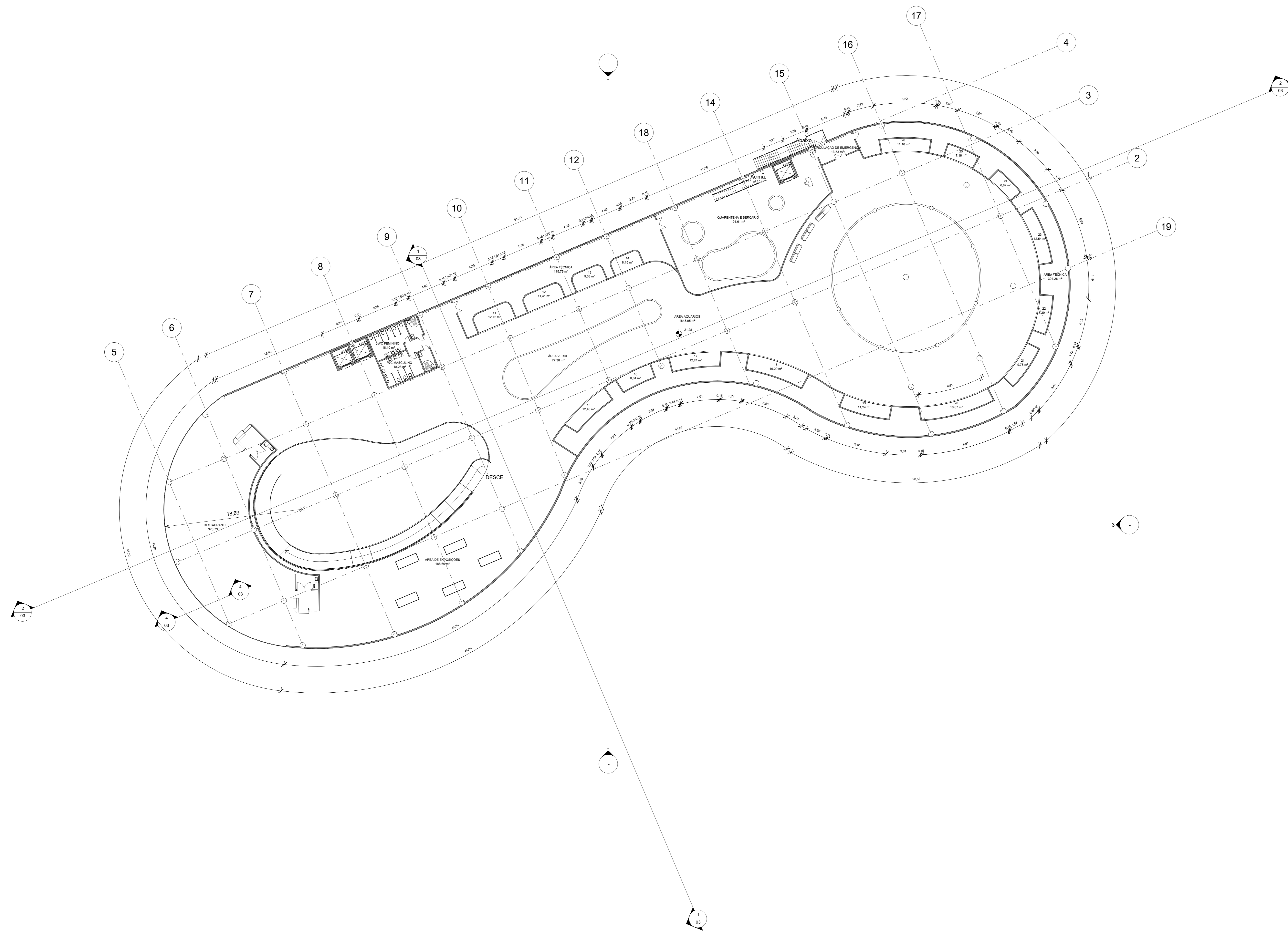
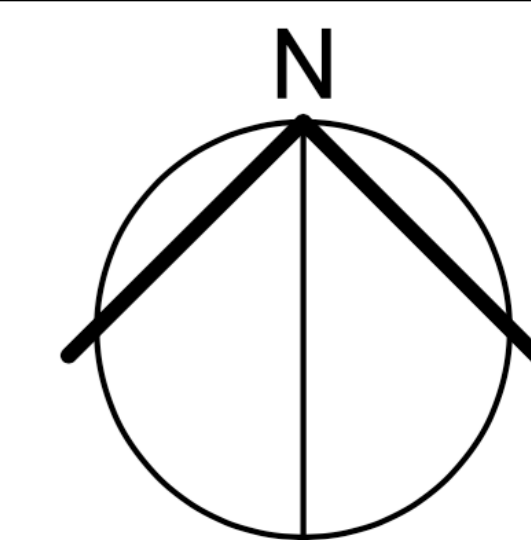

1 2º PAVIMENTO
1 : 200

UNIVERSIDADE FEDERAL DO AMAZONAS			
CURSO	ARQUITETURA E URBANISMO	ALUNA	GIOVANNA PERIN MELO
DISCIPLINA	TFG II	TURNO	VESPERTINO
ORIENTADORA	TAIS FURTADO PONTES	DATA	05/06/2023
TÍTULO	PLANTA BAIXA 2 PAVIMENTO	ESCALA	INDICADA

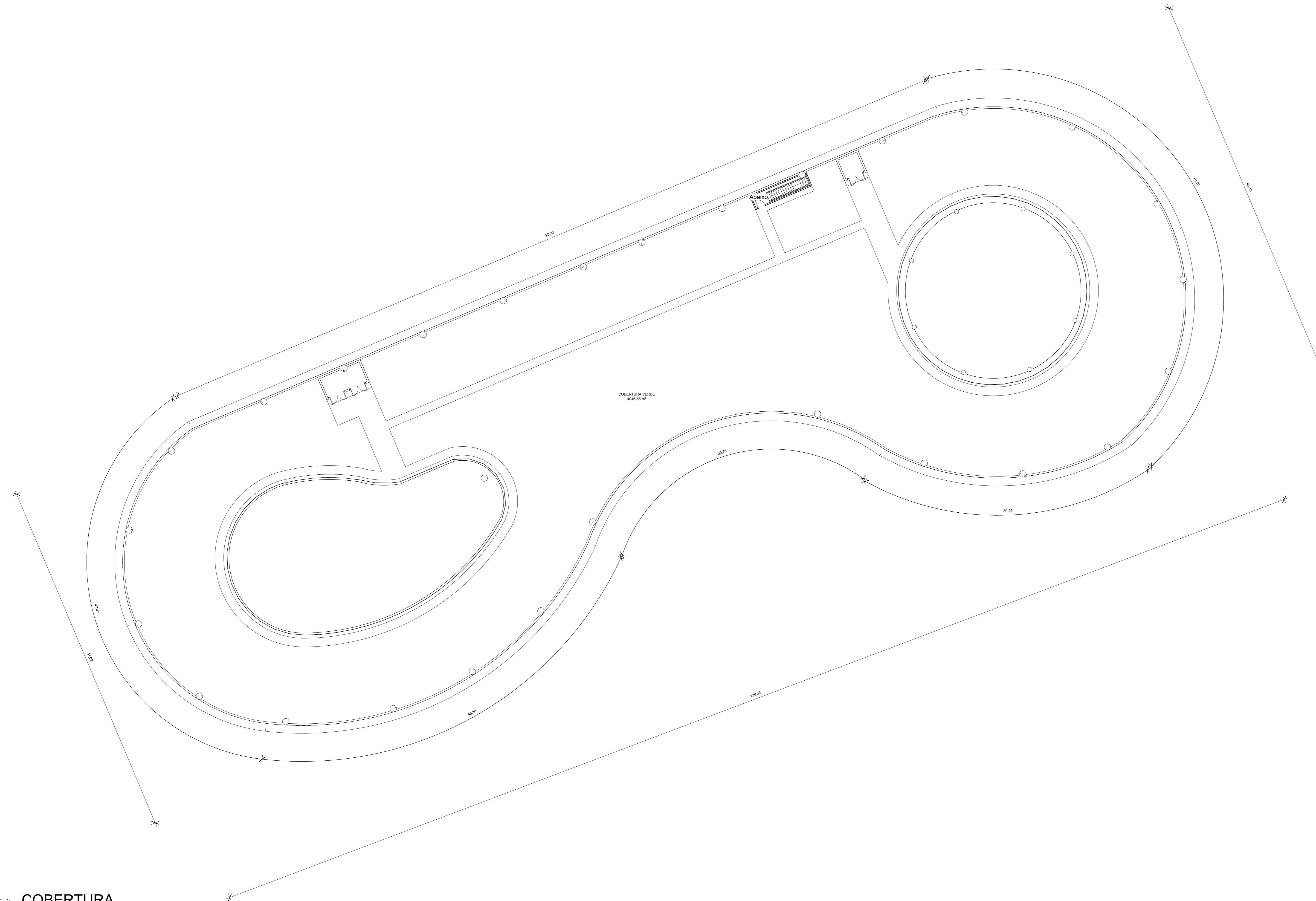
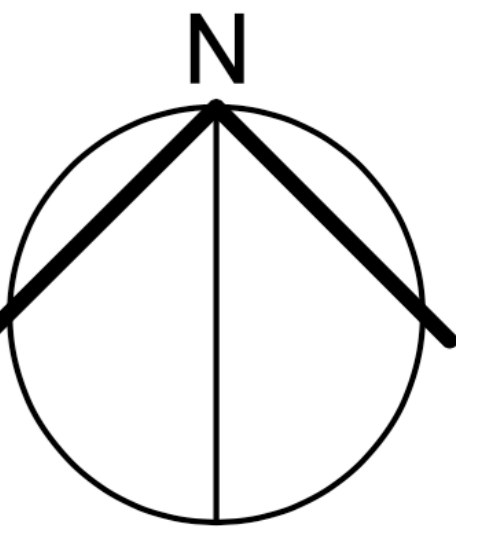

1 COBERTURA
1 : 200

UNIVERSIDADE FEDERAL DO AMAZONAS			
CURSO	ARQUITETURA E URBANISMO	ALUNA	GIOVANNA PERIN MELO
DISCIPLINA	TFG II	TURNO	VESPERTINO
ORIENTADORA	TAIS FURTADO PONTES	DATA	05/06/2023
TÍTULO	ESCALA	INDICADA	05

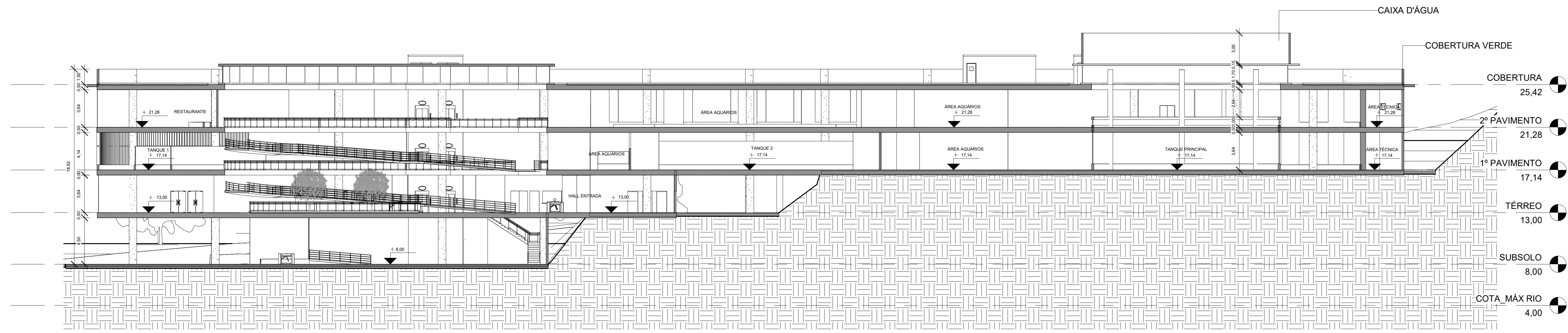
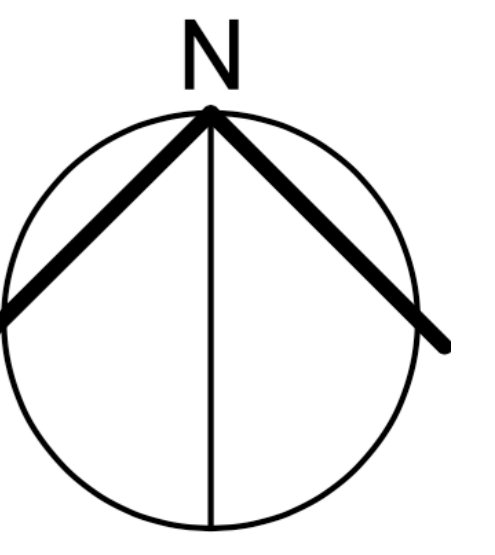

2 Corte BB'
1 : 200

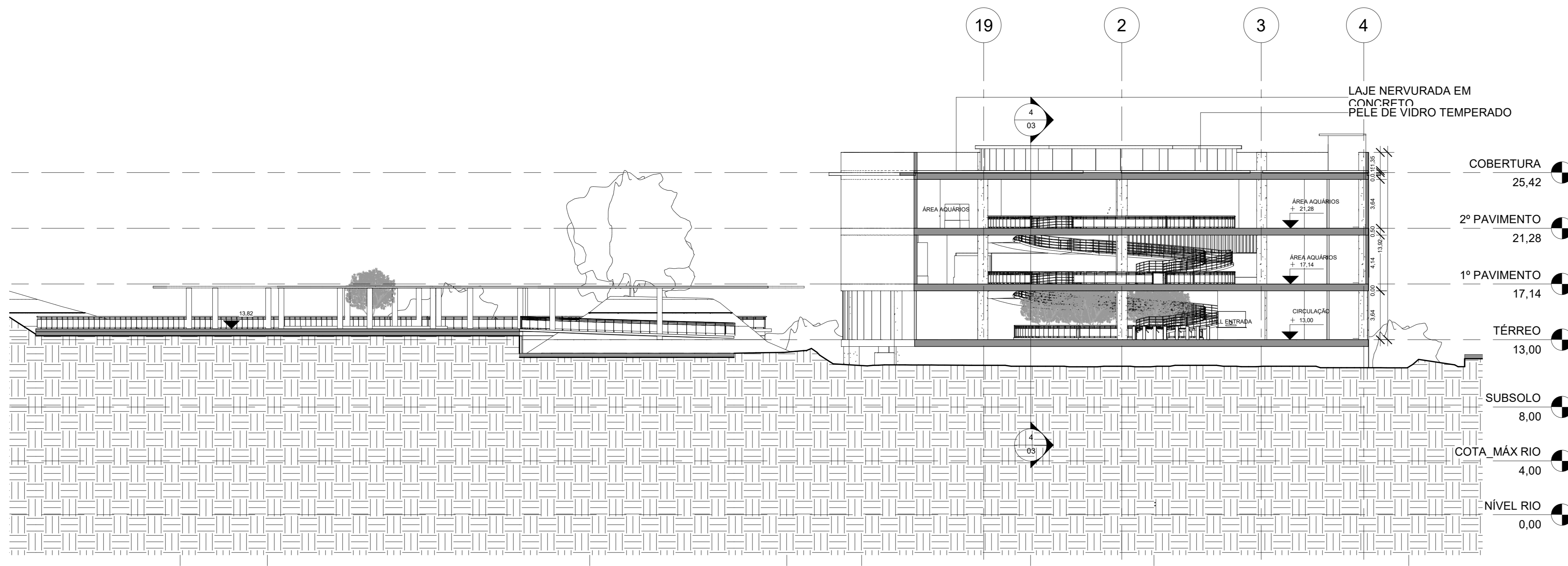

1 Corte AA'
1 : 200

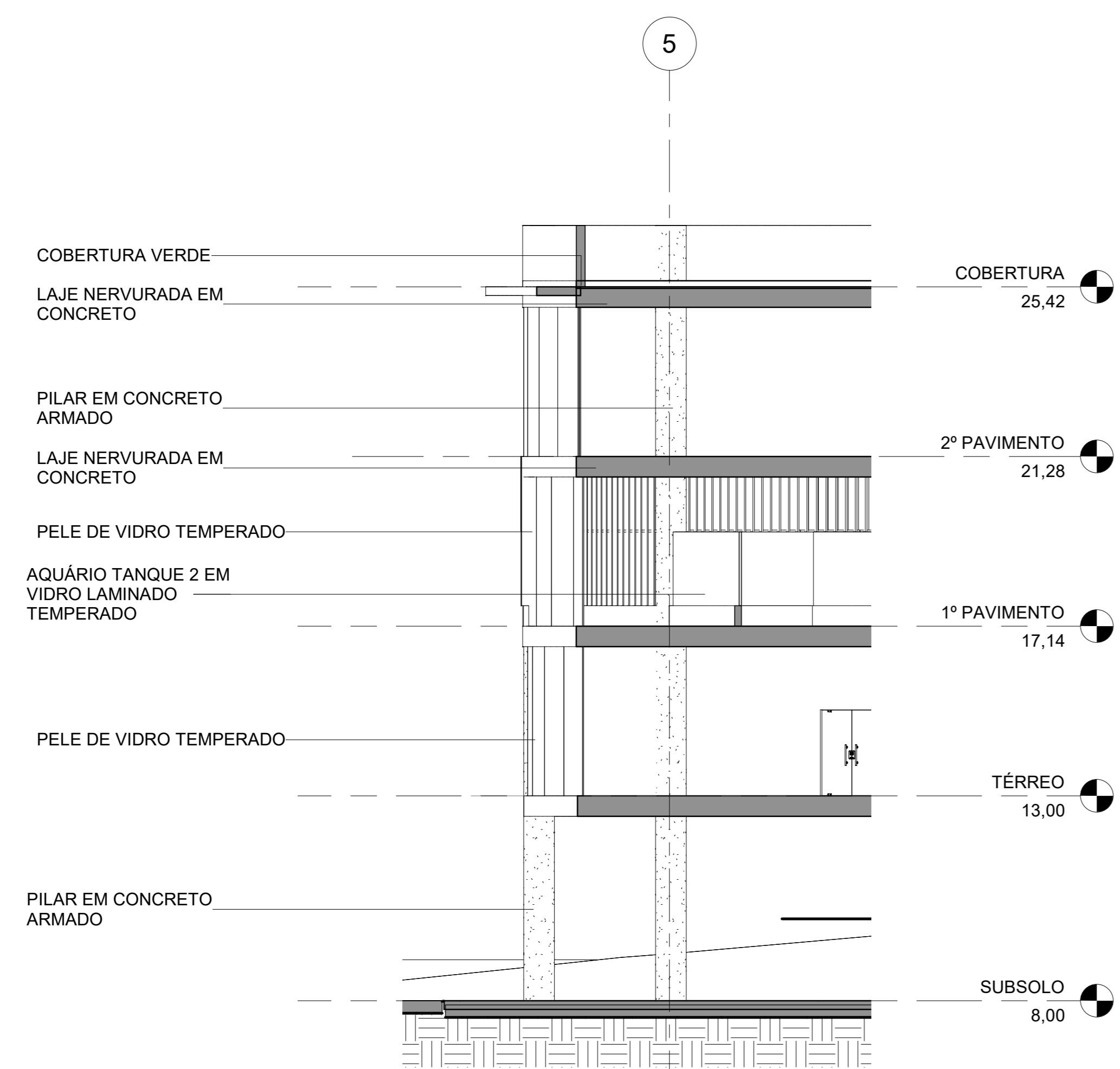

4 Corte 0
1 : 100

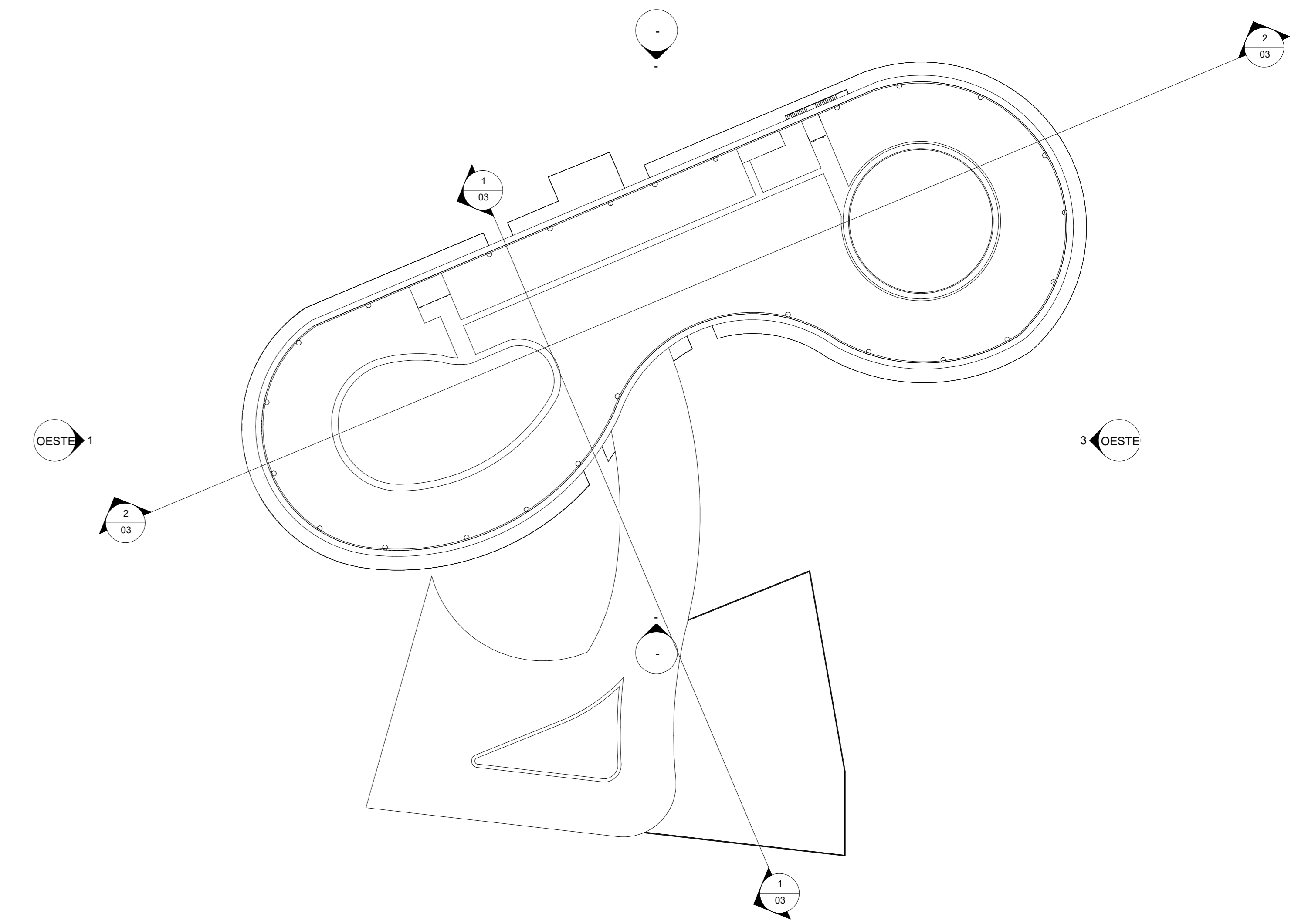

3 PLANTA CHAVE
1 : 500

UNIVERSIDADE FEDERAL DO AMAZONAS			
CURSO	ARQUITETURA E URBANISMO	ALUNA	GIOVANNA PERIN MELO
DISCIPLINA	TFG II	TURNO	VESPERTINO
ORIENTADORA	TAIS FURTADO PONTES	DATA	05/06/2023
TÍTULO	CORTES	ESCALA	INDICADA

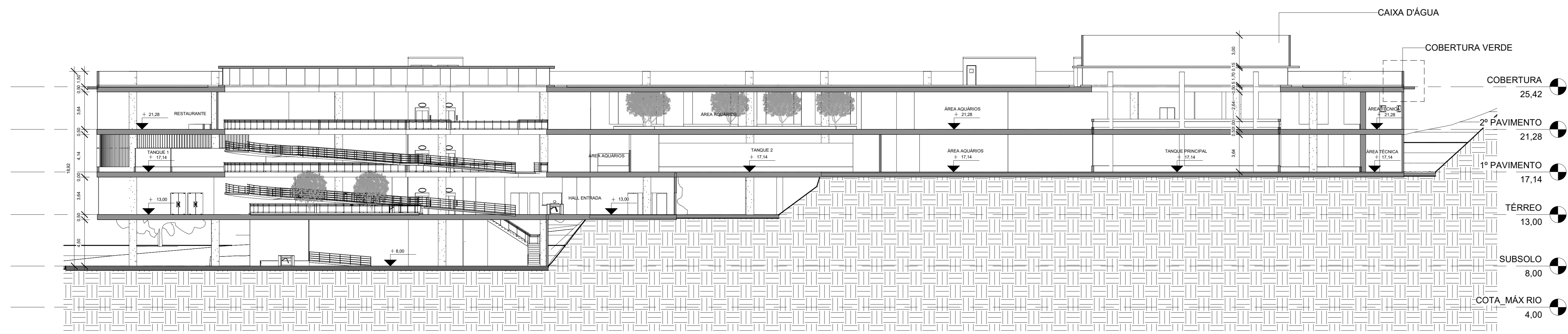

2 Corte BB'
1 : 200

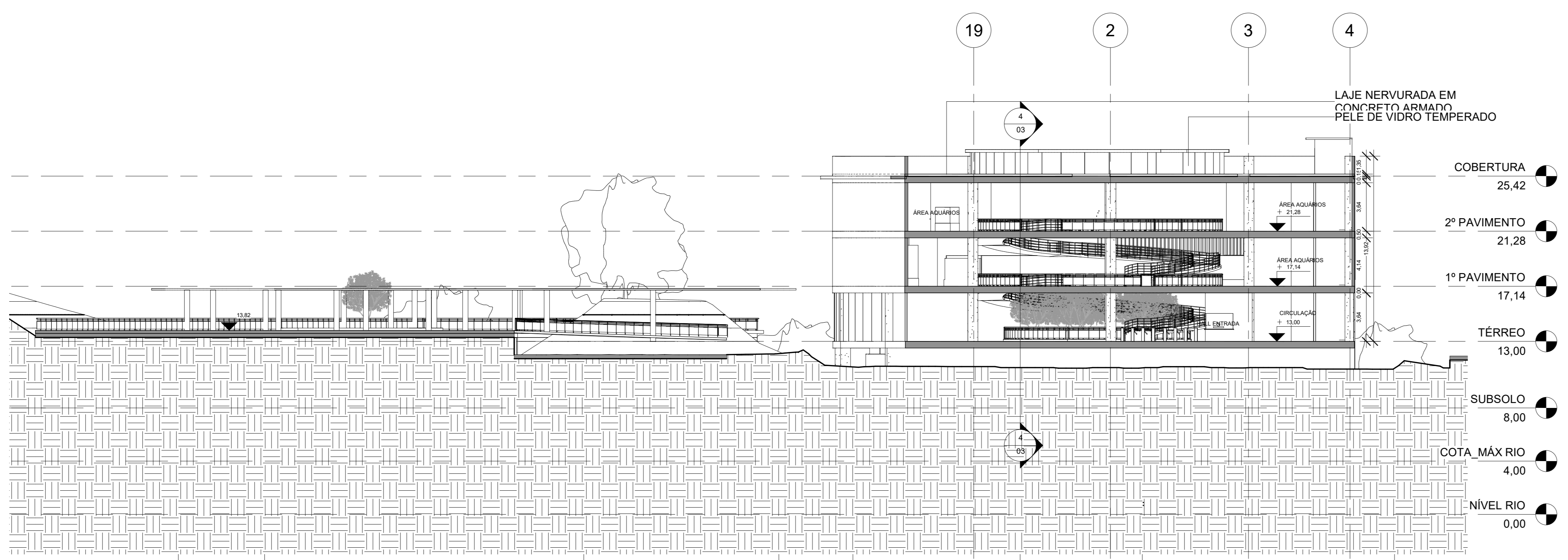
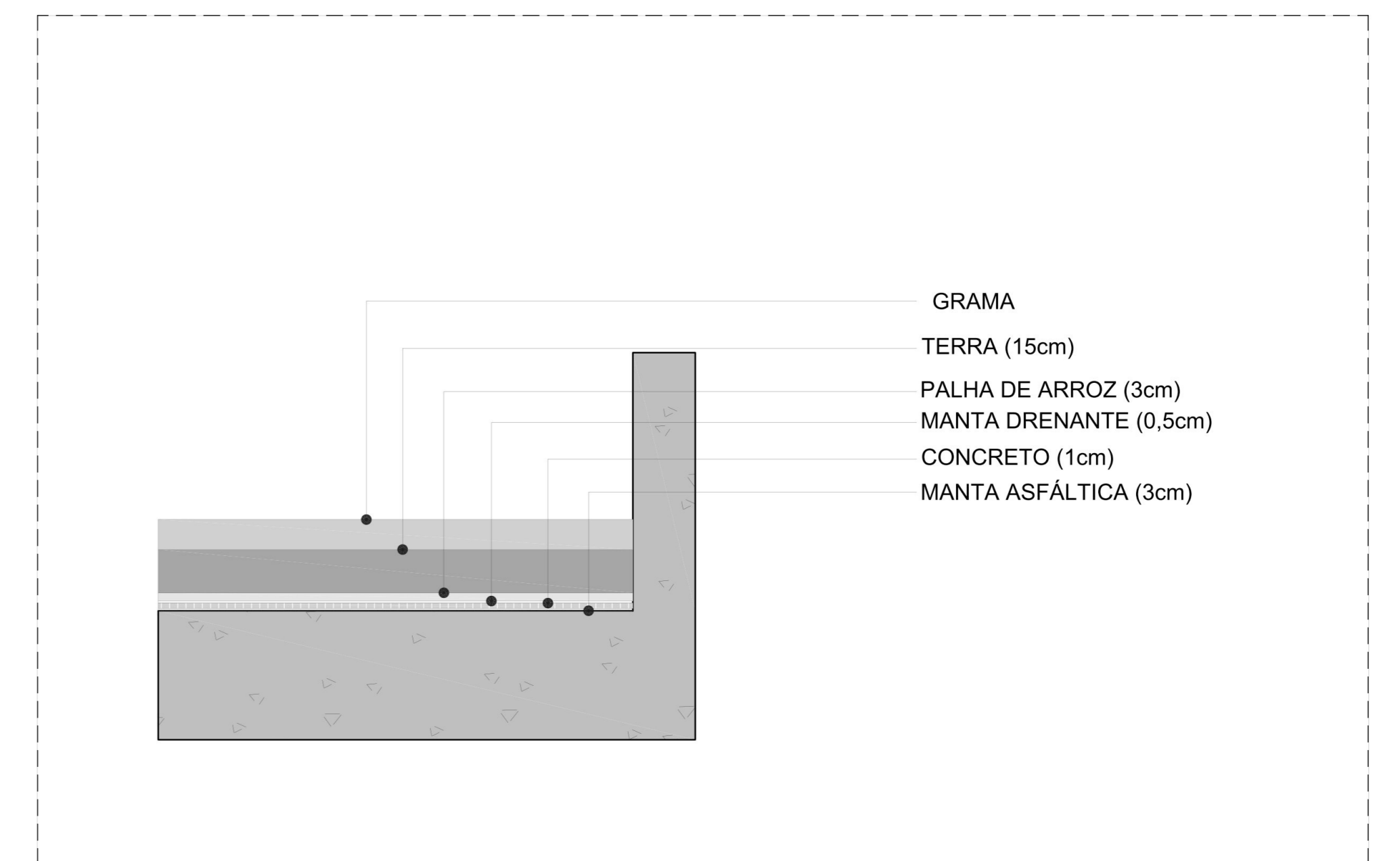

1 Corte AA'
1 : 200

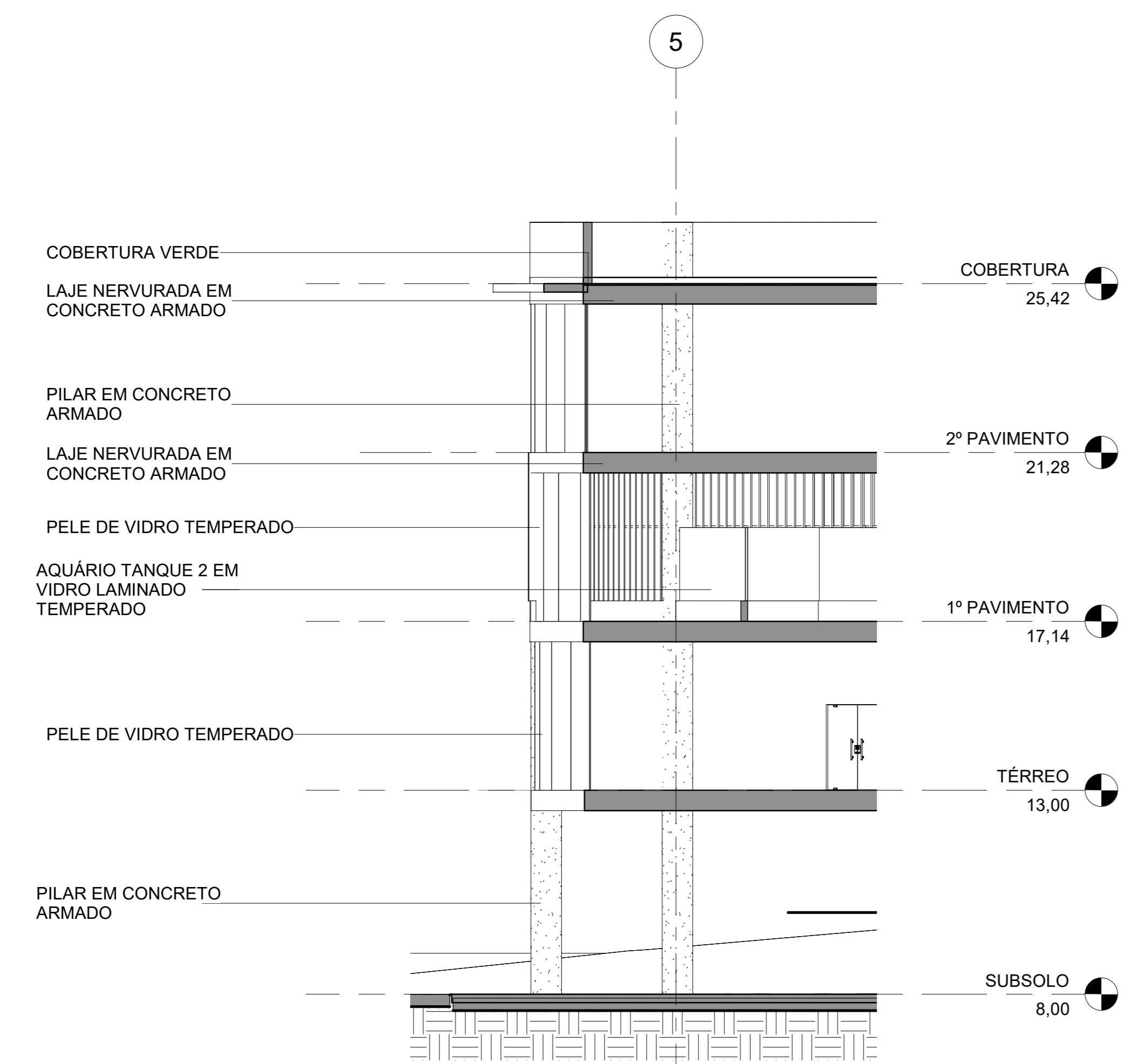

4 Corte 0
1 : 100

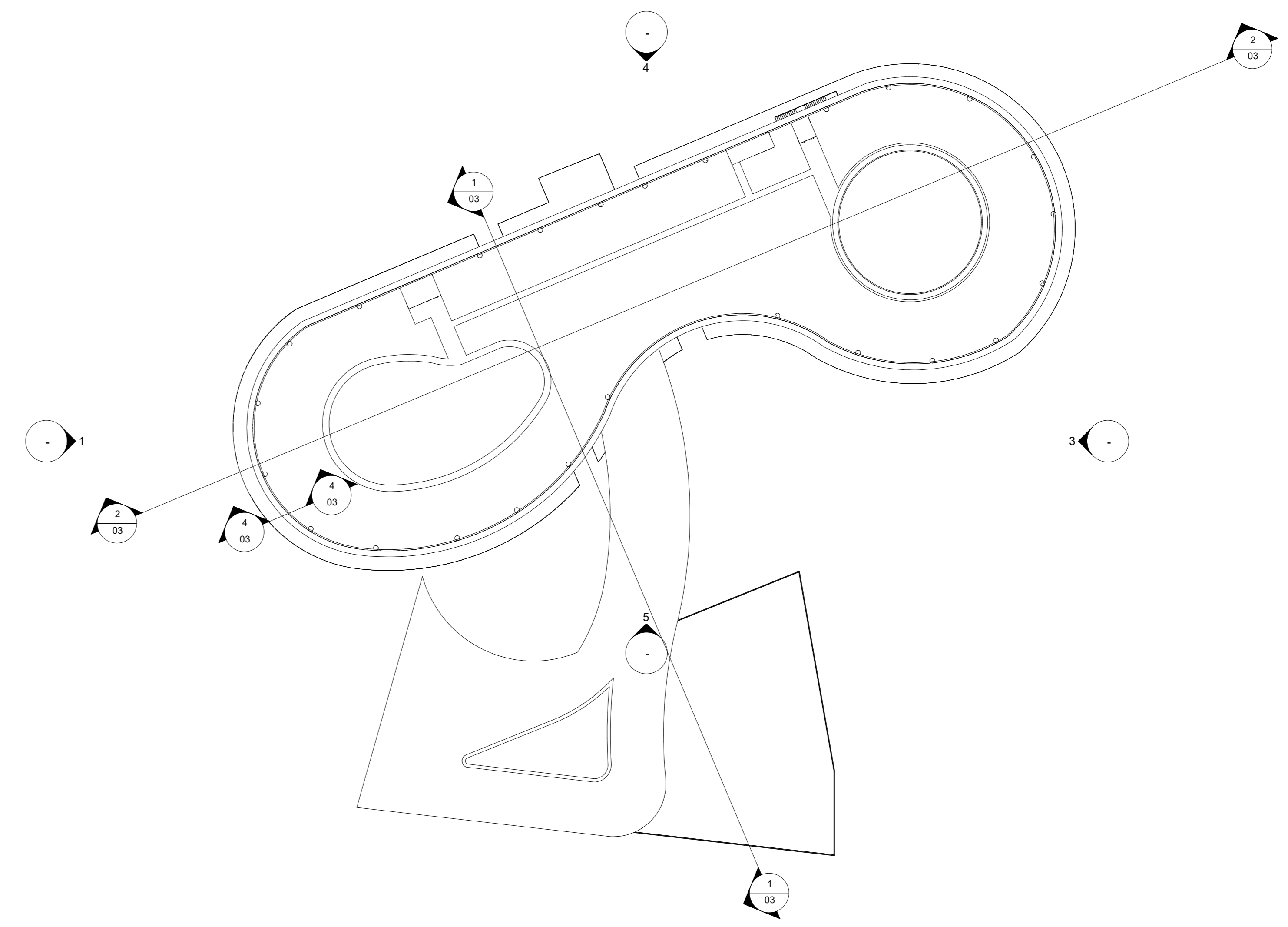

3 PLANTA CHAVE 1
1 : 500

UNIVERSIDADE FEDERAL DO AMAZONAS			
CURSO	ARQUITETURA E URBANISMO	ALUNA	GIOVANNA PERIN MELO
DISCIPLINA	TFG II	TURNO	VESPERTINO
ORIENTADORA	TAIS FURTADO PONTES	DATA	05/06/2023
TÍTULO	CORTES	ESCALA	INDICADA

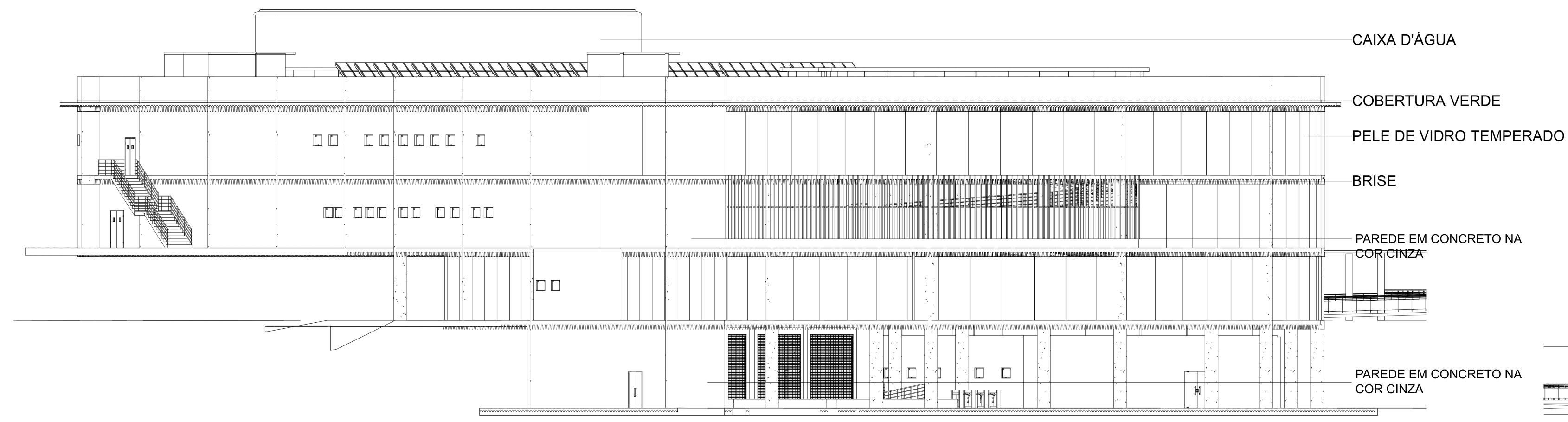
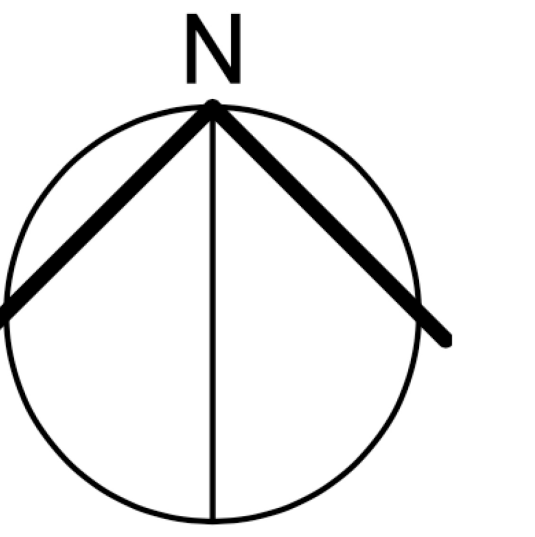

CAIXA D'ÁGUA
 COBERTURA VERDE
 PELE DE VIDRO TEMPERADO
 BRISE
 PAREDE EM CONCRETO NA
 COR CINZA
 PAREDE EM CONCRETO NA
 COR CINZA

1 Oeste
 1 : 200

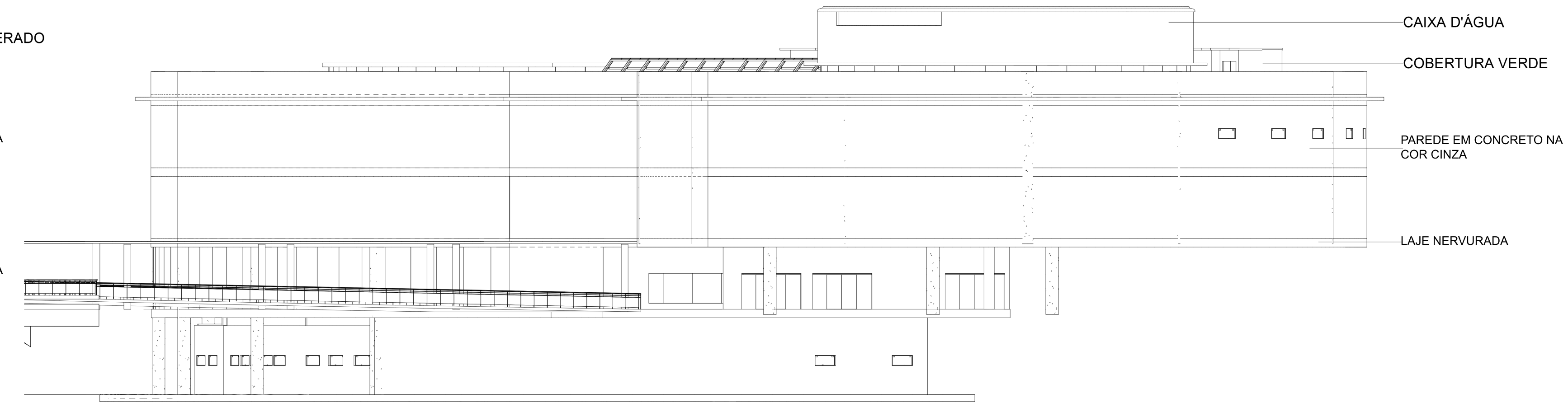

CAIXA D'ÁGUA
 COBERTURA VERDE
 PAREDE EM CONCRETO NA
 COR CINZA
 LAJE NERVURADA

3 Leste
 1 : 200

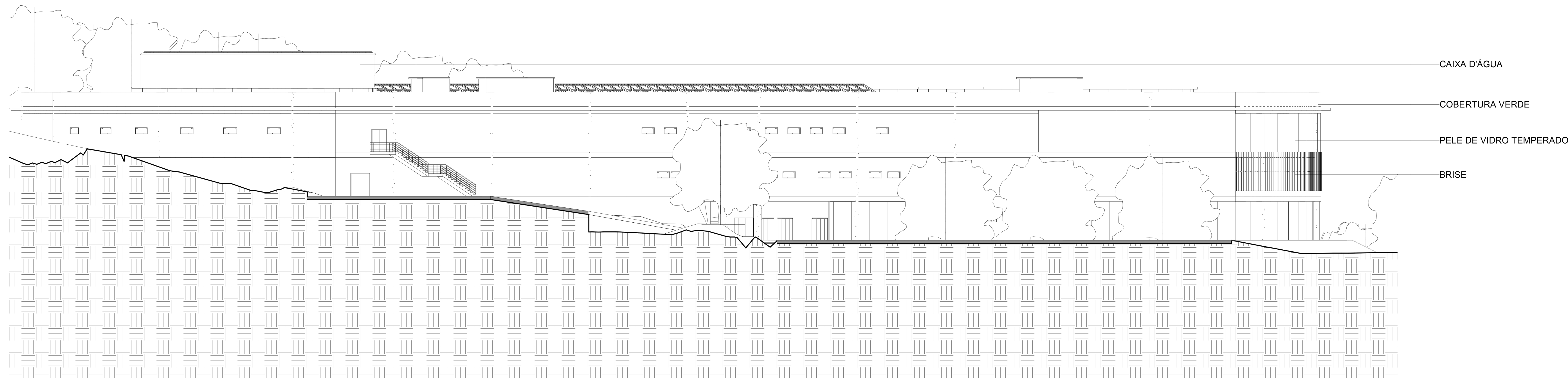

CAIXA D'ÁGUA
 COBERTURA VERDE
 PELE DE VIDRO TEMPERADO
 BRISE

4 Norte
 1 : 200

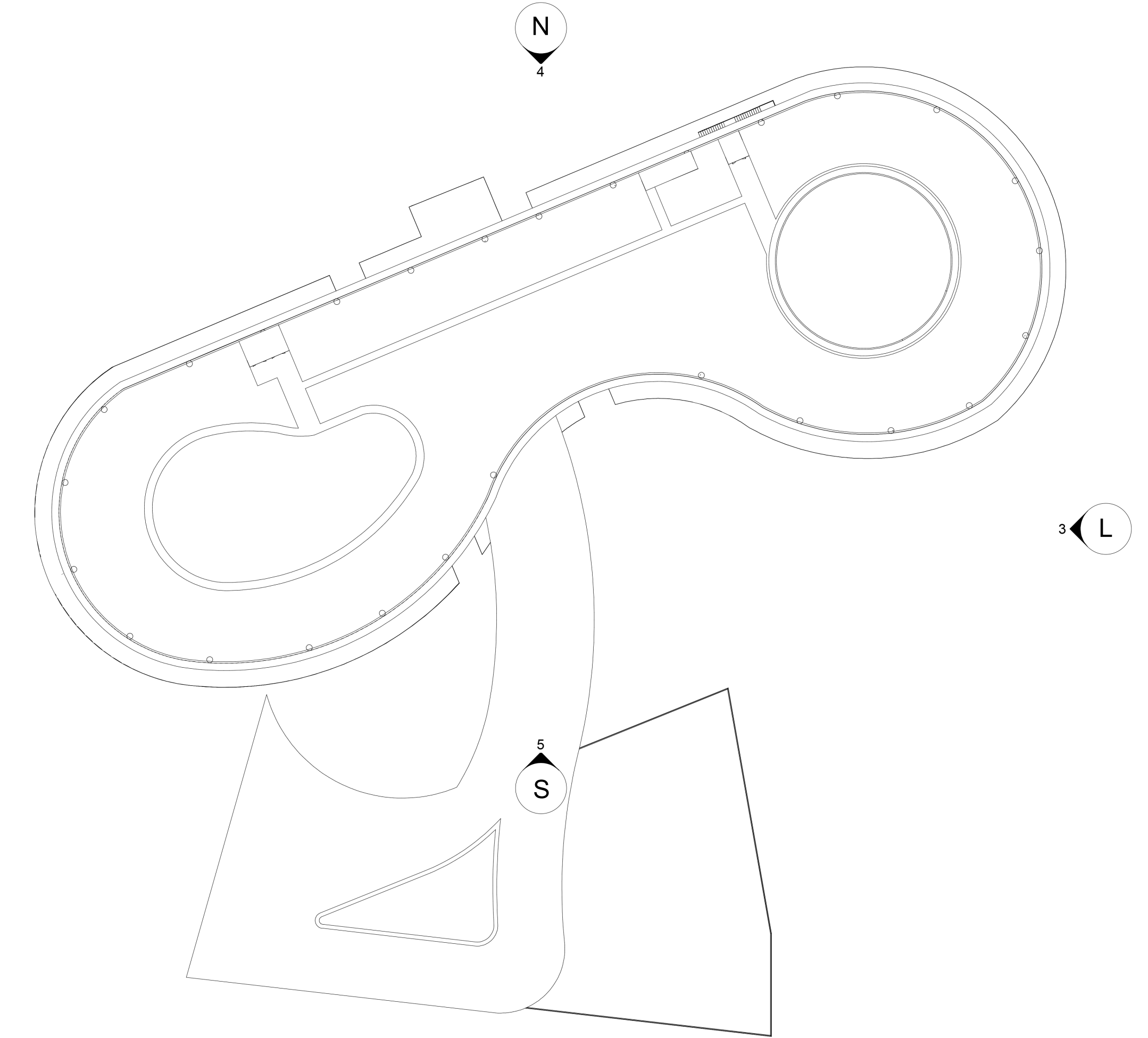

2 PLANTA CHAVE 2
 1 : 500

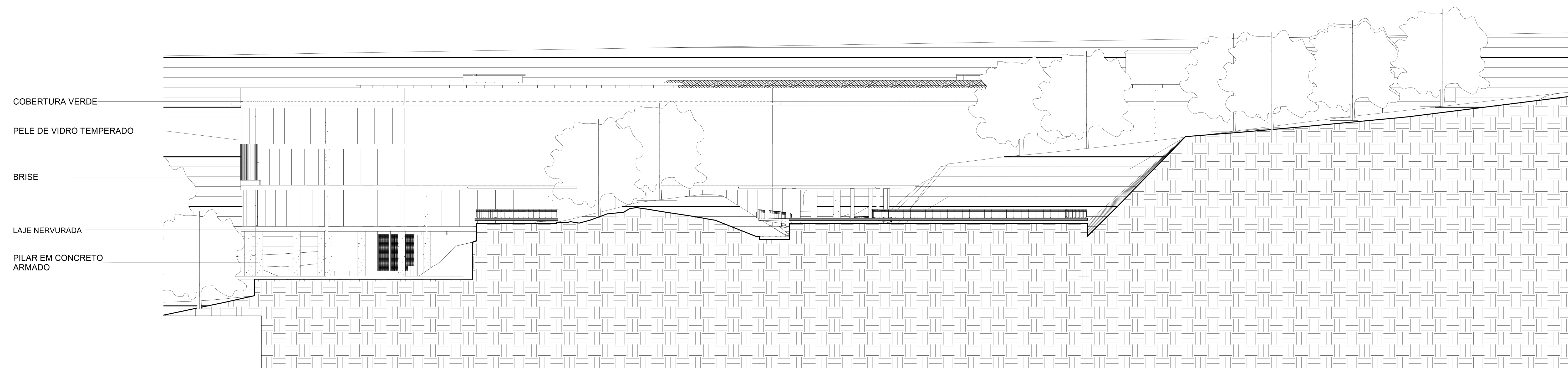

COBERTURA VERDE
 PELE DE VIDRO TEMPERADO
 BRISE
 LAJE NERVURADA
 PILAR EM CONCRETO
 ARMADO

5 Sul
 1 : 200

UNIVERSIDADE FEDERAL DO AMAZONAS			
CURSO	ARQUITETURA E URBANISMO	ALUNA	GIOVANNA PERIN MELO
DISCIPLINA	TFG II	TURNO	VESPERTINO
ORIENTADORA	TAÍS FURTADO PONTES	DATA	05/06/2023
TÍTULO	ELEVAÇÕES	ESCALA	INDICADA

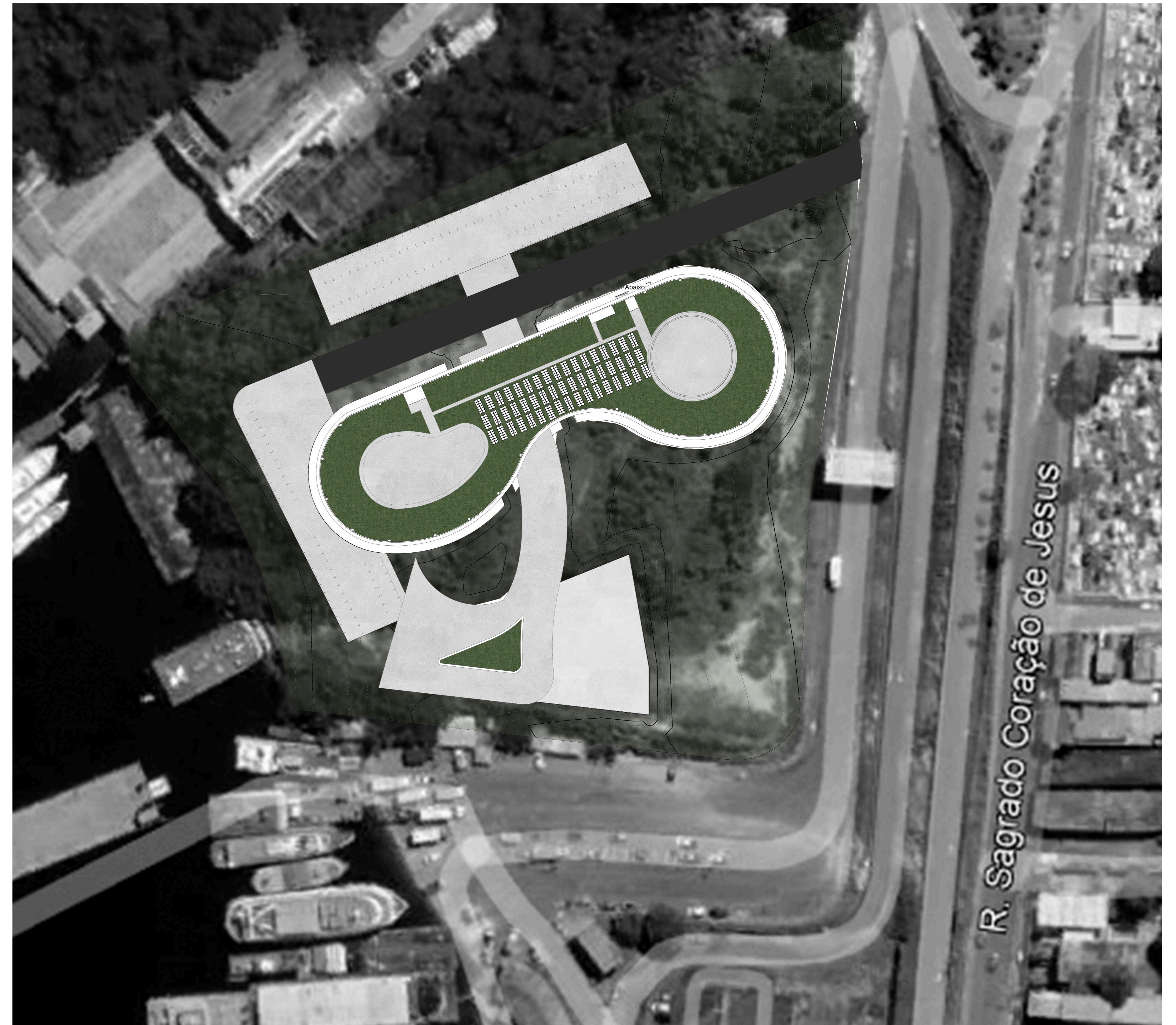
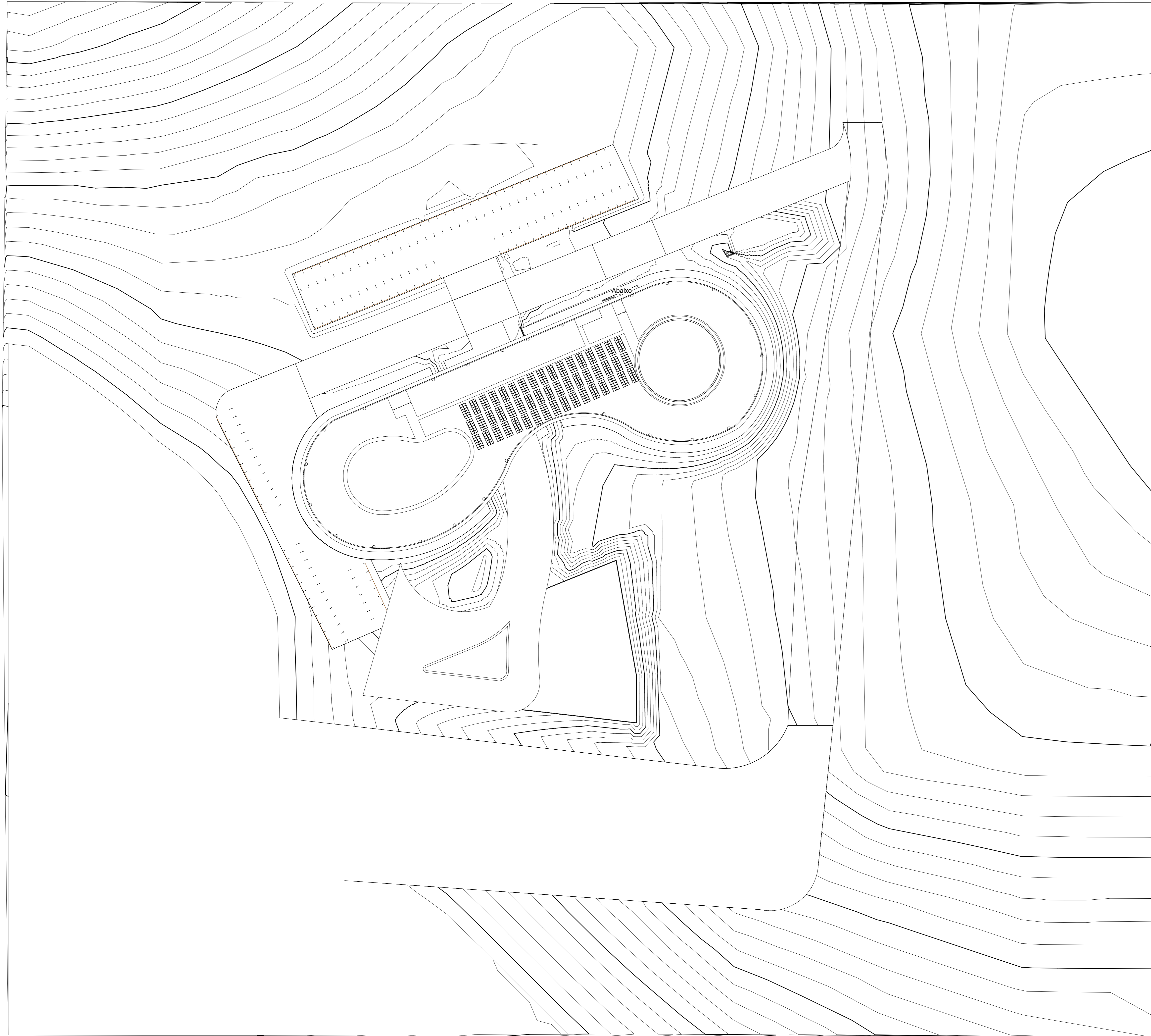
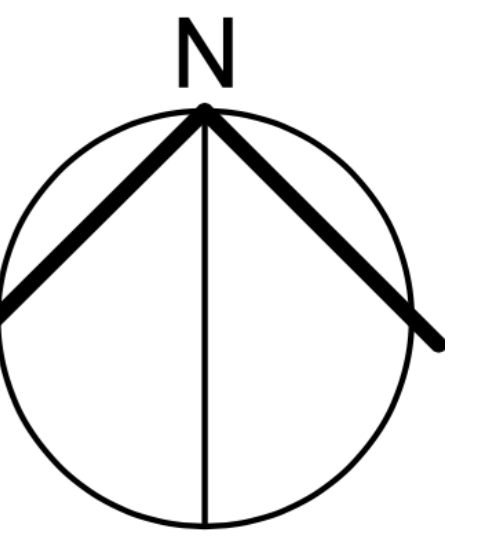

1 Terreno
1: 500

UNIVERSIDADE FEDERAL DO AMAZONAS			
CURSO	ARQUITETURA E URBANISMO	ALUNA	GIOVANNA PERIN MELO
DISCIPLINA	TFG II	TURNO	VESPERTINO
ORIENTADORA	TAÍS FURTADO PONTES	DATA	05/06/2023
TÍTULO	IMPLANTAÇÃO	ESCALA	INDICADA